

IBC™ Brand Cleaner LC Instruction Manual

Thank you for choosing the **IBC Brand Cleaner LC**. The **IBC Brand Cleaner LC** is a high-performance device designed for cleaning the ferrule end faces of LC connectors and MU connectors. Please carefully read these instructions before using this device. Please keep the instructions for future reference.

1. Safety precautions

	Though our device is deemed safe, improper usage or handling can still inflict injury to others.
	IBC Brand Cleaner LC is designed to clean LC connectors and MU connectors only. US Conec is not liable for damage caused in attempt to apply this device to other applications.

2. Notes on usage





- Do **NOT** attempt to disassemble as this can cause damage to the device and void the warranty.
- Do **NOT** try to re-use the cleaning cloth as this will eliminate the cleaner's effectiveness and void warranty.
- Do **NOT** touch the cleaning cloth as this will cause contamination.
- Do **NOT** pull the cleaning cloth, use only the device body.
- Do **NOT** use this cleaner when the cloth is empty. This may can cause damage to the connector.

3. Notes on storage for extended periods

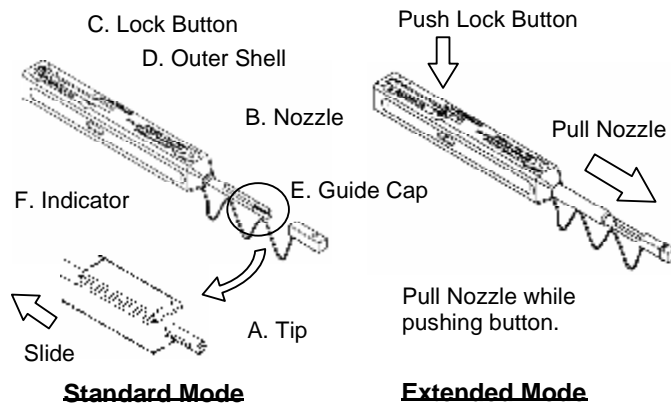
Do not leave the cleaner exposed to to direct sunlight, high temperature or high humidity over an extended period. The dust cap should be closed at all times when device is not in use

4. Cleaner construction

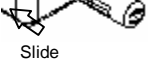

	View of Indicator	View of the Nozzle end
Full	 Cloth (White)	 Tip (Black)
Little	 Cloth (White) Red	 Slide Cloth (White)
Empty	 Red	 Slide Tip (Black) No Cloth (Black)

Identification of remaining cloth.

No.	Part Name	Function
A	Tip	Lead the cleaning cloth to the optical connector end face.
B	Nozzle	Lead tip to the optical connector end face.
C	Lock Button	Push the button to extend and contract the nozzle.
D	Outer Shell	Push the outer shell to clean the connector.
E	Guide Cap	Acts as dust cap or cleaning adapter for connector plug.
F	Indicator	Provides indication of remaining cleaning cloth.

5. Applications

Connector inside adapter

1. Remove Guide Cap from the device.

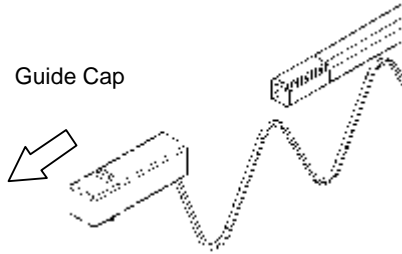

Connector plugs alone

1. Open the Cover on the Guide Cap.

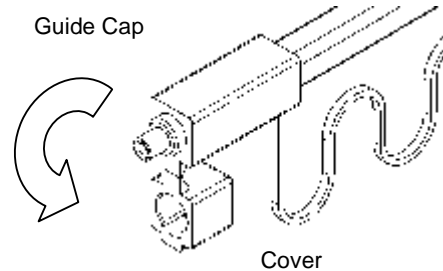

2. Insert tip of cleaner into LC Adapter

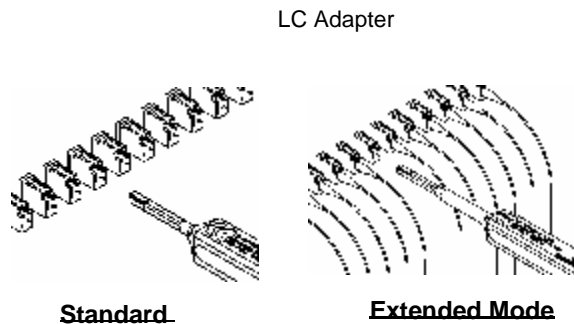

Note: This drawing shows only LC, but this product will clean MU.

2. Insert LC connector into the Guide Cap.

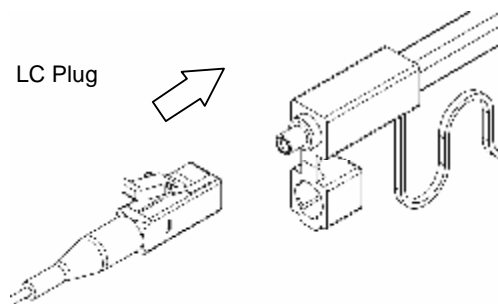

Note: This drawing shows only LC, but this product will clean MU.

3. Push the Outer Shell to start cleaning the LC connector end face. A "pop" sound indicates end of cleaning process. Close the cover after use.

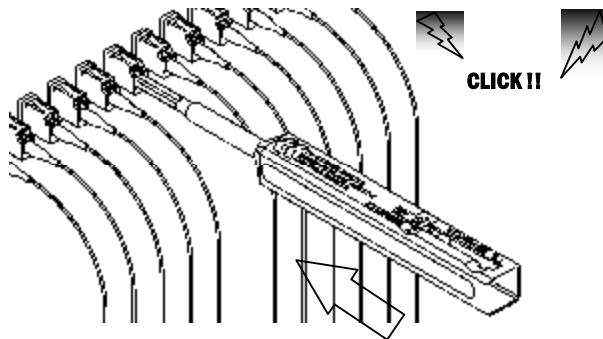

Be careful not to slant the IBC Brand Cleaner LC while inserting into the adapter.

Do not overly exert force during insertion as this may cause damage to both the connector and the IBC Brand Cleaner LC.

If pushing Outer Shell is inhibited, remove IBC Brand Cleaner LC from adapter and ensure that there is no sizable debris inhibiting the cleaning process.

3. Push the Outer Shell to start cleaning the LC connector end face. A "pop" sound indicates end of cleaning process. Close the cover after use.

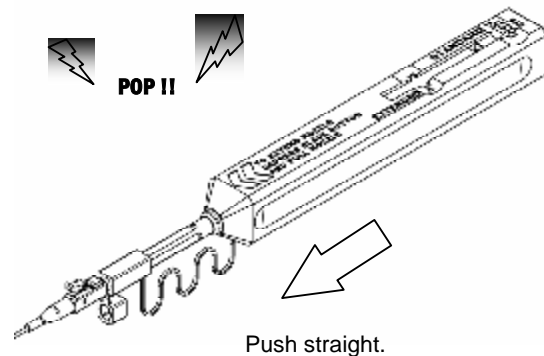

Be careful not to slant LC connector while inserting into the Guide cap.

Do not overly exert force during insertion as this may cause damage to both the connector and the IBC Brand Cleaner LC.

If pushing Outer Shell is inhibited, remove IBC Brand Cleaner LC from adapter and ensure that there is no sizable debris inhibiting the cleaning process.